





Model for Integrated Port-Based Industrial Area Development in the Sustainability of Regional Development in Sorong Regency, Indonesia



Slamet Widodo^{1,2*}, Batara Surya³, Muhamad Arif Nasution⁴, Murshal Manaf³

¹ Urban and Regional Planning Doctoral Program, Universitas Bosowa, Makassar 90231, South Sulawesi, Indonesia

² Department of Civil Engineering, Muhammadiyah University Sorong, Sorong 98416, Indonesia

³ Urban and Regional Planning Program, Engineering Faculty, Universitas Bosowa, Makassar 90231, South Sulawesi, Indonesia

⁴ Agrotechnology Study Program, Agriculture Faculty, Universitas Bosowa, Makassar 90231, South Sulawesi, Indonesia

Corresponding Author Email: slametwido2810@gmail.com

Copyright: ©2024 The authors. This article is published by IIETA and is licensed under the CC BY 4.0 license (<http://creativecommons.org/licenses/by/4.0/>).

<https://doi.org/10.18280/ijstdp.191227>

ABSTRACT

Received: 20 January 2024

Revised: 1 November 2024

Accepted: 29 November 2024

Available online: 30 December 2024

Keywords:

industrial area, integrated ports, regional development, sustainability

Management of industrial-port areas and spatial connectivity as a trigger for sustainable regional development. An integrated growth model for industrial-port areas for sustainable regional development. This research aims to analyze the relationship between industrial zones, spatial connectivity, and integrated ports on regional development in realizing sustainable development, as well as the growth model of industrial areas based on integrated ports for sustainable regional development in Sorong Regency. This research uses a quantitative approach with the structural equation modeling (SEM-PLS) method. Data were collected through observation, documentation, and survey. This research highlights the crucial role of integrated industrial zones and ports in driving regional development and sustainable growth, emphasizing the importance of effective management, government policies, and infrastructure development, while also considering social and environmental factors for inclusive and sustainable development. Research as a reference in designing policies for planning and managing integrated port areas in sustainable regional development.

1. INTRODUCTION

The concept of regional sustainable development has gained significant attention in recent years, linking the practical framework of sustainable development principles to regional and global scales and contributing to the sustainability of broader spatial systems [1]. Strategies and alternatives for intervening policies to achieve regional development must be designed to balance in favor of sustainable development [2]. Rural-urban groupings into regional planning units can create an enabling environment for expanding trade networks and spatial linkages [3]. Therefore, regional development and sustainable development, especially in the balance of the most remote areas as a balance of regional economic growth, need to be examined to see whether this main concept will have relevance to local regional organizations.

The role of ports in regional development has been a topic of great interest among academics and policymakers. Ports are important nodes in the global supply chain, serving as gateways for international trade and contributing to the economic growth of the surrounding regions [4, 5]. As the global economy becomes more interconnected, the importance of efficient and well-developed ports is increasing [6].

Ports are catalysts for economic development [7]. The close relationship between ports, local economies, and global logistics networks highlights the importance of port connectivity in driving economic growth [8]. Logistics integration and network orientation at the port drive spatial development and enhance central and regional networks [7]. In addition to the role of regional development and sustainable development, it is necessary to balance the main drivers in the form of industrial estates, integrated ports, and spatial connectivity to regional development in Sorong Regency, Southwest Papua Province, Indonesia.

As a maritime nation, Indonesia relies on ports and maritime transport, which play an important role in economic movement and growth, especially in eastern regions such as Sorong. With 88% of transport by sea, improving port policy, management, and connectivity is a priority to support growth and connectivity [9]. According to BKPM (2020), Sorong Port has potential as a sea toll node and plays an important role as a transport gateway in West Papua and Papua. The port supports the flow of passengers, goods, export activities, and local economic growth. As a land-sea transition area, the port is a strategic node that encourages the progress of the surrounding area.

2. BASIC THEORY: CONFIRMING THE INTEGRATION OF PORT-BASED INDUSTRIAL AREAS IN SUSTAINABLE DEVELOPMENT

Port-industry-city is a prime driver of economic development and promotes the integration of port, industry, and city [10]. Different variations in port integration promote city economic growth, especially in small and medium-sized cities. The impact is less in large urban centers, due to the spatial variations in the study [11]. In the case of Indonesia, the concept of integrated areas (industrial areas and ports) effectively increases the economic potential and welfare of the community, both locally and regionally [12]. In the case of inland ports, significant economic impacts on the city often result in larger spillover effects in the surrounding region [13]. The case in Indonesia shows that the current management of industrial areas is inadequate and unsustainable, as evidenced by community involvement, the low quality of life of residents around industrial areas, and the lack of utilization of local resources [14].

The impact of port-industry integration is to promote production factor agglomeration, local economic growth, and resources, but limit the development of neighboring regions. In addition, it expands the industrial chain, increases infrastructure investment, and supports mobility and regional cooperation [10, 11]. The concept of the relationship between industrial estates, port integration, and regional development in Indonesia can be focused on the impact of regional economic growth on less developed areas such as Sorong Regency, where the impact on surrounding areas is also less beneficial and the importance of balance between regional economic growth and sustainable development.

Accessibility is a factor in shaping patterns of land use change, socio-economic interactions, and spatial relationships. However, the complexity of these interactions requires careful consideration of various factors, including the specific characteristics of different land-use types, the scale of analysis, and local geographical variations [15-19]. Port integration generally positively impacts the economy, and varies across regions and city sizes. Integration of port resources has helped foster optimal sharing of port functions, which promotes regional economic development [20]. However, challenges remain, such as the need to align development priorities between central and local governments and to clarify the use of subsidies to avoid potential competition for overlapping hinterland areas [21].

Regional development policies cover various aspects, including infrastructure development, investment in human resources, regional integration, and technological innovation [22]. Successful execution of this policy considers factors such as political stability, financial resources, and regional cooperation. Industrial policy factors contribute to regional economic growth [23]. However, it is imperative to balance top-down decision-making with inclusive governance to ensure regional economic, socio-political, labor, policy support, spatial development & infrastructure value to industrial parks in sustainable development and effectively address regional imbalances.

Economic development in transport infrastructure spending contributes significantly to economic growth [24]. Infrastructure can enhance sustainable economic growth and population welfare. Regional disparities in economic development still exist in the unequal distribution of social and economic infrastructure [25]. This gap underscores the need

for targeted policy initiatives to improve economic and social infrastructure in underdeveloped regions, accelerate economic growth, and reduce regional inequality [26]. Regional development under this approach can factor in social and demographic factors, as well as regional infrastructure support, which can promote sustainability by addressing regional disparities and promoting balanced growth.

There is a lack of in-depth empirical evidence to examine the relationship and influence between accessibility, distance, population movement patterns, and land change patterns on spatial relationships. Economy, labor, and spatial developments to an integrated port. Regional economic value, social politics, labor, policy support, spatial & infrastructure development towards industrial areas. Economic development. Social and demography, regional infrastructure support for regional development. Furthermore, environmental quality level, socials, production process, waste and emissions management, strategic area infrastructure, port throughput value, and government policy support to sustainable development.

This concept is crucial for statistical testing of theory, especially through the use of analytical methods that can quantitatively measure the interactions between these factors. Appropriate statistical testing, such as multivariate analysis with structural equation modeling, can provide further insight into how these factors influence each other and the extent to which these indicators contribute to the variables of industrial parks, integrated ports, and spatial linkages to sustainable regional development. By conducting statistical tests, this research will help validate existing theories and clarify the relationships between variables. Based on the research problem above, confirming the relationship requires constructing theoretical concepts and development models. This research intends to answer the following research questions:

- Analyzing the relationship between industrial zones, spatial connectivity, and integrated ports on regional development in realizing sustainable development in Sorong Regency
- How the growth model of an integrated port-based industrial area for sustainable regional development in Sorong Regency

This research is very important to fill the theoretical void in developing an integrated port-based industrial area growth model for regional development sustainability in Sorong Regency with a multivariate analysis method based on structural equation modeling (SEM-PLS). This study focuses on regional growth and development based on the integration of industrial areas and the distribution of ports along the coast in Sorong Regency. The urgency of this research lies in strengthening the integration of industrial areas and ports as a manifestation of sustainable regional development.

3. METHODOLOGY

3.1 Research approach

This research uses a survey-based quantitative approach with multivariate statistics by explaining measurement and structural confirmation. This research design defines exploring the relationship of the theoretical reality of aspects

of industrial estates, spatial linkages, and integrated ports to regional development in realizing sustainable development in Sorong Regency, Southwest Papua Province. This quantitative survey can be used to collect data on the characteristics, status, and quality of life of the community and is conducted through various methods, including direct and indirect surveys [27]. To ensure the quality and usability of survey data, researchers should focus on consistent documentation, utilizing flexible and robust data structures, and making research results easily accessible [28]. With a quantitative survey approach, it is easy to determine the sample and the sampling procedure when conducting a quantitative survey.

3.2 Study area

The research location is in the Integrated Industrial and Port Development Area in Sorong Regency, which includes 5 districts, namely: Aimas District, Mariat District, Mayamuk District, Salawati District, Mosigin District, and Seget District (Figure 1 and Table 1). The selection of the research location was based on the following considerations:

- a) The Sorong Regency integrated port and industrial

development area was selected based on its status as a strategic area.

- b) This area has the potential for great natural resources supported by industrial and port development and activities.
- c) Centres of activity are growing and developing predominantly along the coastal areas, with the region's strategic value in the Pacific Ocean. This potential is a trigger in supporting the welfare and sustainability of the region.

Table 1. Study area

District	Wide (Km ²)	Percentage of Main District Area (%)	Number of Villages/ Subdistricts
Aimas	690,06	5,27	14
Mariat	542,19	4,14	11
Mayamuk	542,19	4,14	11
Salawati	345,03	2,63	7
Mosigin	443,61	3,39	9
Seget	443,61	3,39	9

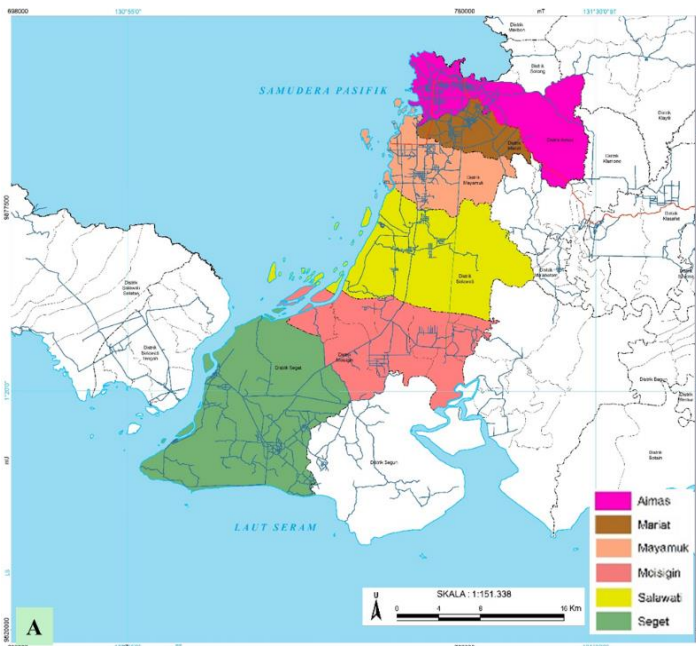

Figure 1. A. Study location map, B. Port conditions

3.3 Sample and data collection

The sample used was 200 respondents, justified based on maximum likelihood estimation from the recommended sample size between 100 and 200 [29]. Data sources in this study were obtained through field observations, documents, surveys, and interviews. The data sources are as follows:

- Observation and documentation in this study are used to meet data needs related to the physical condition of the port in several locations, conditions around the port, port management conditions, and social and economic conditions of the community around the area.
- The survey was conducted through questionnaires and interviews to collect perception data related to

regional development, ports, and sustainability in Sorong Regency. The focus of the survey included economic, socio-political, labor, policy, infrastructure, spatial connectivity, accessibility, and the impact of the port on the economy and labor. Environmental quality, waste management, and policy support were also analyzed.

Indicators are measured using a Likert scale through questions in a questionnaire and scored as follows: (1) strongly disagree; (2) disagree; (3) neither agree nor disagree; (4) agree; (5) strongly agree.

3.4 Data analysis method

The analysis method used quantitative descriptive analysis

of the data collected from the survey, which was then examined and integrated into Smart-PLS 3. Structural Equation Modeling (SEM) is a statistical technique for testing relationships between variables, both directly measured and latent, and analyzing causal relationships within theoretical models [30]. The Structural Equation Modeling (SEM-PLS) process is conducted simultaneously with the measurement and structural processes to build a model [31]. This conceptual model builds a confirmation of the adaptation relationship in the form of disaster resilience. Variables in this study include industrial area (IA) as independent or exogenous variables, spatial linkages (SI), integrated port (IP), regional development (Y1) as intervening variables, and development sustainability (Y2) as dependent or endogenous variables. The indicators are shown in Figure 2 and Table 2.

Based on the path relationships in the proposed research model above, the hypotheses are as follows:

- H1:** Industrial areas affect regional development.
- H2:** Spatial linkages affect regional development.
- H3:** Integrated Port affects regional development.
- H4:** Regional development affects sustainable development.

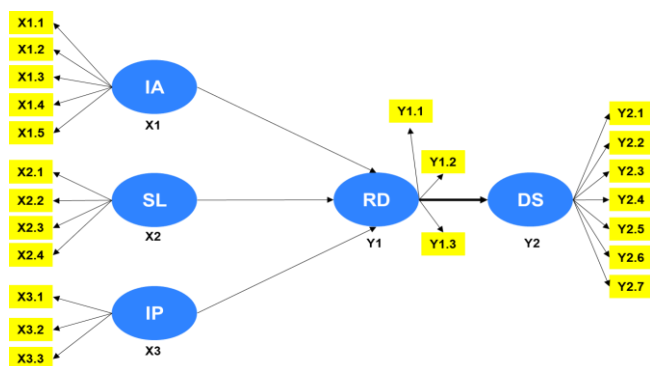

Figure 2. The research proposed model

Table 2. Variables and research indicators

Category	Code	Indicators
Industrial Areas (IA)	X1.1	Regional Economic Value
	X1.2	Social Politics
	X1.3	Labors
	X1.4	Policy Support
	X1.5	Spatial & Infrastructure Development
Spatial Linkages (SL)	X2.1	Accessibility
	X2.2	Distance
	X2.3	Population Movement Patterns
	X2.4	Land Use Patterns
Integrated Port (IP)	X3.1	Economy
	X3.2	Labors
	X3.3	Spatial Developments
Regional Development (RD)	Y1.1	Economic Development
	Y1.2	Social and Demography
	Y1.3	Regional Infrastructure Support
Development Sustainability (DS)	Y2.1	Environmental Quality Level
	Y2.2	Socials
	Y2.3	Production Process
	Y2.4	Waste and Emissions Management
	Y2.5	Strategic Area Infrastructure

Category	Code	Indicators
	Y2.6	Port Throughput Value
	Y2.7	Government Policy Support

Source: Author elaborator

4. RESULTS

4.1 Influence of industrial zones, spatial linkages, and integrated ports on sustainable regional development in Sorong Regency

4.1.1 Measurement model analysis (Outer model)

The results of the concurrent validity test show that all indicators have met the criteria with an outer loading value ≥ 0.7 , which means these indicators are valid constructs. Five indicators are used to describe the industrial areas (IA) variable: labor (0.691), policy support (0.686), social politics (0.538), regional economic value (0.724), and spatial & infrastructure development (0.624). The largest contributor among these is policy support (0.921). Accessibility (0.765), distance (0.822), population mobility patterns (0.757), and land use patterns (0.779) are the four indicators that make up the spatial linkages (SL) variable. The largest contribution is made by distance (0.919). Labor (0.960) makes the largest contribution to the integrated port (IP) variable, which also comprises economy (0.684), labor (0.676), and spatial developments (0.652). Economic development (0.927) is the leading indicator of the regional development (RD) variable, which is made up of economic development (0.766), social and demographic support (0.692), and regional infrastructure support (0.729). Finally, the development sustainability (DS) variable comprises socials (0.792), environmental quality level (0.743), socials (0.792), production process (0.852), waste and emissions management (0.775), key area infrastructure (0.799), port throughput value (0.723), and government policy support (0.741). The AVE values and outer loadings of each indicator show strong validity (Table 3).

The analysis results show that each indicator used in this study has a strong relationship with the measured variables and is reliable in representing each variable. In industrial areas, focusing on policies and infrastructure is key, with government policy support being crucial for industrial economic growth. Spatial linkages are influenced by accessibility and distance, which emphasizes the importance of transportation and distribution planning in strengthening connectivity between regions. For integrated ports, the quality and availability of skilled labor play a significant role, followed by the economic role and spatial development in ensuring the efficiency and sustainability of the ports. In regional development, economic development and infrastructure support are the main factors for sustainable regional growth. Lastly, sustainable development demands attention to environmental quality, production processes, and waste management, with government policies supporting environmentally and socially friendly practices as an integral part of sustainability.

The simultaneous validity test results show that the outer variable values meet the criteria of ≥ 0.7 , confirming that these variables are valid constructs. Additionally, the assessment of discriminant validity, based on the latent construct, revealed high values for the square root of AVE. Specifically, the industrial area is 0.759, spatial connectivity is 0.819, the integrated port is 0.907, regional development is 0.793, and sustainable development is 0.733 (see Table 4). Among these,

the spatial connectivity variable shows the highest correlation. According to the Fornell-Larcker criteria, all latent constructs- industrial zones, spatial connectivity, integrated ports,

regional development, and sustainable development-show strong discriminant validity (Figure 3).

Table 3. Validity and reliability indicators

Indicator (Code)	Average Variance Extracted (AVE)	Cronbach's Alpha	Composite Reliability Average (Rho_A)	Composite Reliability Convergent (Rho_C)
Regional economic value (X1.1)	0.724	0.872	0.88	0.913
Social politics (X1.2)	0.538	0.784	0.798	0.852
Labors (X1.3)	0.691	0.851	0.852	0.899
Policy support (X1.4)	0.686	0.922	0.925	0.938
Spatial & infrastructure development (X1.5)	0.624	0.913	0.915	0.930
Accessibility (X2.1)	0.765	0.897	0.902	0.928
Distance (X2.2)	0.822	0.892	0.893	0.933
Population movement patterns (X2.3)	0.757	0.840	0.852	0.903
Land use patterns (X2.4)	0.779	0.905	0.907	0.934
Economy (X3.1)	0.684	0.907	0.909	0.928
Social (X3.2)	0.676	0.904	0.906	0.926
Spatial developments (X3.3)	0.652	0.932	0.937	0.944
Economic development (Y1.1)	0.766	0.898	0.901	0.929
Social and demography (Y1.2)	0.692	0.780	0.795	0.870
Regional infrastructure support (Y1.3)	0.729	0.925	0.927	0.942
Environmental quality level (Y2.1)	0.743	0.824	0.876	0.895
Social (Y2.2)	0.792	0.912	0.915	0.939
Production process (Y2.3)	0.852	0.913	0.915	0.945
Waste and emissions management (Y2.4)	0.775	0.941	0.942	0.954
Strategic area infrastructure (Y2.5)	0.799	0.916	0.916	0.941
Port throughput value (Y2.6)	0.723	0.801	0.880	0.884
Government policy support (Y2.7)	0.741	0.956	0.957	0.963

Notes: Loading Factor >0.70, CR>0.70, AVE>0.50 [32]. Source: Author elaborator

Table 4. Internal consistency reliability

Laten Variable (Code)	Cronbach's Alpha	Rho_A	CR	AVE
Industrial area	0.920	0.923	0.940	0.759
Spatial linkages	0.926	0.929	0.948	0.819
Integrated port	0.948	0.950	0.967	0.907
Regional development	0.870	0.895	0.920	0.793
Sustainability development	0.939	0.943	0.950	0.733

Notes: AVE>0.50 [32]. Source: Author elaborator

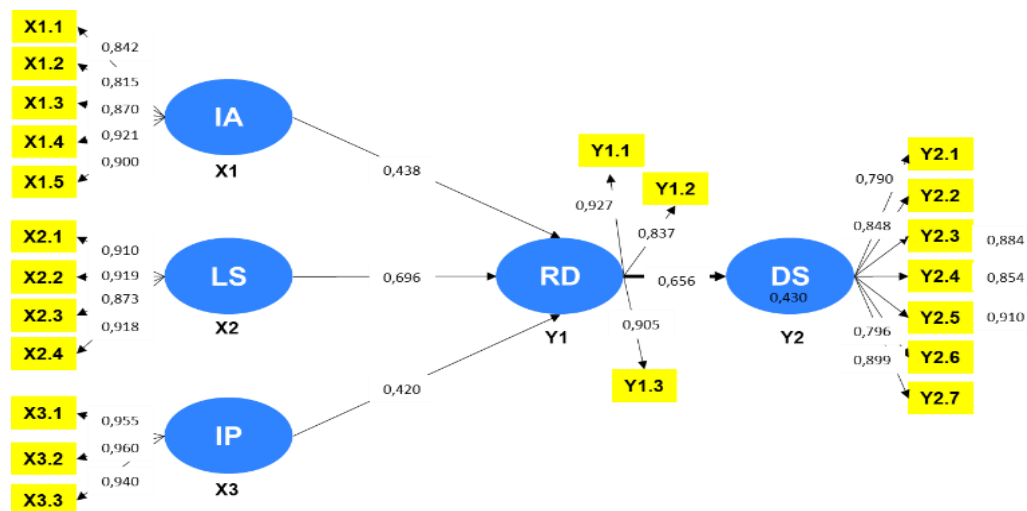

Figure 3. Loading factor second order outer model

Source: Author elaborator

4.1.2 Structural model analysis (Inner model)

Integrated industrial and port areas have a notable and positive influence on regional development, as both paths demonstrate substantial statistical significance (T-statistics well above 1.96 and P-values below 0.05). On the other hand, spatial connectivity does not substantially affect regional development, as shown by low T-statistics and high P-values. Furthermore, regional development exerts a highly significant positive effect on sustainable development, with very high T-statistics and a P-value of 0.000 (Table 5).

Table 5. Results of path coefficient values and p values

Path	T Statistics	P Values
Industrial area -> regional development	4.162	0.000
Spatial linkages -> regional development	0.053	0.958
Integration port > regional development	3.376	0.001
Regional development -> sustainability development	9.918	0.000

Notes: **t-value is below 1.96 and *p<0.05. Source: Author elaborator

Industrial areas and integrated ports have a notable and positive impact on regional development, whereas spatial connectivity does not demonstrate a meaningful effect on regional development. Furthermore, regional development strongly and positively contributes to sustainable development. In conclusion, the hypothesis that industrial areas, integrated ports, and regional development drive sustainable development is confirmed, while the hypothesis concerning spatial connectivity is not substantiated.

4.2 Integrated industrial-port area growth model for sustainable development

The relationship of industrial zones affects regional development, this finding reinforces and expands Kalat's research in the study of Notteboom et al. [7]. Our findings reinforce the confirmation path that explains the need for the management and development of industrial zones focused on policies and the development of space and infrastructure, with government policy support being crucial for industrial economic growth as a driving force for regional development based on strengthening economic development and regional infrastructure support.

Integrated port relationships influence regional development, these findings are in line with, reinforce, and expand upon the research of Zhao et al. [10]. Our findings emphasize the direct and indirect pathways that explain the need for integrated port connectivity for the development of integrated ports. The quality and availability of skilled labor play a crucial role, followed by the economic role and spatial development in ensuring the efficiency and sustainability of the ports, as well as being a driving force for regional development based on strengthening economic development and regional infrastructure support.

The relationship between regional development affects sustainable development, and these findings are in line with, reinforce, and expand upon the research by Nijkamp et al. [1] and Balanzo et al. [2]. Our findings reinforce the confirmation path that explains that regional development requires economic growth and infrastructure support as the main factors for regional growth and as a driving force for realizing sustainable development, supported by improving environmental quality in waste and emission management,

strategic area infrastructure, and strong regulatory and policy support from the government.

5. DISCUSSION

Industrial areas, integrated ports, regional development, and sustainable practices all play a pivotal role in driving the growth of industrial-port zones. The establishment of the Special Economic Zone in Sorong has become a key catalyst for transforming the region's economic structure, spatial organization, and planning strategies. The manufacturing sector has been a primary driver of regional economic growth during the 2021-2022 period. However, this sector faces several challenges, such as limited accessibility, inadequate road infrastructure, and inconsistent land use patterns, all of which must be urgently addressed. With effective planning and management, the Sorong Special Economic Zone holds significant potential to improve regional connectivity, enhance logistics efficiency, and strengthen the supply chain, positioning Sorong Regency to shift from an underdeveloped area to a more prosperous and developing region.

The concept of an integrated industrial port area in sustainable regional development underscores the need for synergy between industrial activities, ports, and regional development. The industrial zone acts as an economic hub, supported by an integrated port that enhances logistics connectivity and streamlines supply chain efficiency. This synergy is further strengthened by the provision of essential infrastructure, environmental improvements through waste and emission control, and government policies aimed at fostering long-term economic growth, environmental preservation, and social inclusion. Furthermore, the research highlights that both environmental sustainability and social factors are critical for successful regional development. Effective environmental management, including emission reduction, waste disposal, and ecosystem conservation, ensures that industrial activities are sustainable without harming the environment. On the social front, policies that foster community participation, worker welfare, and equality contribute to building social cohesion, which is vital for achieving sustainable development. The robustness of environmental and social indicators demonstrates that inclusive and sustainable management of industrial zones is central to driving regional economic growth in Sorong Regency.

6. CONCLUSION

This research demonstrates that integrated industrial zones and ports play a crucial role in fostering regional development and achieving sustainable growth. Industrial zones serve as economic hubs that stimulate regional expansion, while integrated ports improve logistics connectivity and supply chain efficiency and enhance the region's economic competitiveness. Although spatial connectivity has not been proven to directly influence regional development, regional development itself emerges as a key driver of sustainable development, with economic growth, infrastructure enhancement, and environmental management playing vital roles in this process.

This research provides new insights into the importance of managing integrated industrial zones and ports as the main

drivers of regional and sustainable development. These findings also highlight the crucial role of government policies in supporting infrastructure and connectivity development, as well as in considering social and environmental factors to achieve inclusive and sustainable development. Overall, the results of this research can serve as a reference in designing more effective planning and management policies to optimize the potential of industrial areas and ports in supporting sustainable regional development.

7. RECOMMENDATIONS

For further development, this research needs to consider broader factors tailored to the characteristics of the research location. Exploring alternative methodologies to identify influential factors will provide additional references. Data sources can also be expanded by incorporating insights from secondary data related to economic progress. On the policy side, the results of this research can serve as a basis for formulating strategies to improve the status of the underdeveloped Sorong Regency.

8. LIMITATIONS

This research has limitations, particularly the exploration of industrial area typologies and port zones based on their hierarchy or class has not been conducted. Therefore, if the types or classifications of existing industries and ports are identified beforehand, significant influencing factors can be systematically categorized, thereby strengthening these findings.

ACKNOWLEDGMENT

The authors would like to thank the Sorong Regency Local Government and Pelindo Office, the Director and the Industrial Zone Office, and all respondents for their comprehensive support, both technical and non-technical, throughout this research.

REFERENCES

- [1] Nijkamp, P., Van den Bergh, C.J.M., Soeteman, F.J. (1990). Regional sustainable development and natural resource use. *The World Bank Economic Review*, 4(suppl_1): 153-188. https://doi.org/10.1093/wber/4.suppl_1.153
- [2] Balanzo, A., Garavito, L., Rojas, H., Sobotova, L., Pérez, O., Guaquetá, D., Mojica, A., Pavajeau, J., Sanabria, S. (2020). Typical challenges of governance for sustainable regional development in Globalized Latin America: A multidimensional literature review. *Sustainability*, 12(7): 2702. <https://doi.org/10.3390/su12072702>
- [3] Akkoyunlu, S. (2015). The potential of rural-urban linkages for sustainable development and trade. *International Journal of Sustainable Development & World Policy*, 4(2): 20. <https://doi.org/10.18488/journal.26/2015.4.2/26.2.20.40>
- [4] Murati, M., Brokaj, R. (2014). The role of marketing Sea ports for the development of tourism. *Academic Journal of Interdisciplinary Studies*, 3(2): 265-272. <https://doi.org/10.5901/ajis.2014.v3n2p265>
- [5] Gekara, V.O., Chhetri, P. (2013). Upstream transport corridor inefficiencies and the implications for port performance: A case analysis of mombasa port and the northern corridor. *Maritime Policy & Management*, 40(6): 559-573. <https://doi.org/10.1080/03088839.2013.776716>
- [6] Belmoukari, B., Audy, J.F., Forget, P. (2023). Smart port: A systematic literature review. *European Transport Research Review*, 15(1): 4. <https://doi.org/10.1186/s12544-023-00581-6>
- [7] Notteboom, T., Pallis, A., Rodrigue, J.P. (2022). *Port Economics, Management and Policy*. Routledge. <https://doi.org/10.4324/9780429318184>
- [8] Li, Y., Xia, X., Huang, Q. (2024). Port shipping connectivity as a new driver of urban exports in the context of dual circulation: Evidence from China. *Transport Policy*. <https://doi.org/10.1016/j.tranpol.2024.10.006>
- [9] Zaman, M.B., Vanany, I., Awaluddin, K.D. (2015). Connectivity analysis of port in Eastern Indonesia. *Procedia Earth and Planetary Science*, 14: 118-127. <https://doi.org/10.1016/j.proeps.2015.07.092>
- [10] Zhao, D., Dongmei, X., Wei, D. (2024). Research on Port-Industry-City integration and its spatial spillover effects: Empirical evidence from the Bohai sea rim region. *Applied Spatial Analysis and Policy*, 17(4): 1653-1679. <https://doi.org/10.1007/s12061-024-09599-2>
- [11] Ma, Q., Jia, P., She, X., Haralambides, H., Kuang, H. (2021). Port integration and regional economic development: Lessons from China. *Transport Policy*, 110: 430-439. <https://doi.org/10.1016/j.tranpol.2021.06.019>
- [12] Purba, B.M., Nuraini, C. (2024). Integrated area development as a sectoral and regional development model (Kuala Tanjung Industrial and Port Area). *East Asian Journal of Multidisciplinary Research*, 3(7): 3159-3176. <https://doi.org/10.55927/eajmr.v3i7.10219>
- [13] Wu, Z., Woo, S.H., Lai, P.L., Chen, X. (2022). The economic impact of inland ports on regional development: Evidence from the Yangtze River region. *Transport Policy*, 127: 80-91. <https://doi.org/10.1016/j.tranpol.2022.08.012>
- [14] Iskandar, S., Zitri, I., Pratama, I.N. (2024). Socioeconomic-Based management strategies for industrial areas in West Sumbawa Regency. *International Journal of Sustainable Development & Planning*, 19(9): 3509-3518. <https://doi.org/10.18280/ijstdp.190919>
- [15] Haugen, K., Vilhelmsen, B. (2013). The divergent role of spatial access: The changing supply and location of service amenities and service travel distance in Sweden. *Transportation Research Part A: Policy and Practice*, 49: 10-20. <https://doi.org/10.1016/j.tra.2013.01.001>
- [16] Shoman, W., Demirel, H. (2022). Impedance measures in evaluating accessibility change. *Geocarto International*, 37(12): 3642-3657. <https://doi.org/10.1080/10106049.2020.1869327>
- [17] Fan, P.Y., Chun, K.P., Mijic, A., Tan, M.L., Zhai, W., Yetemen, O. (2024). Identifying the impacts of land-Use spatial patterns on street-network accessibility using geospatial methods. *Geographical Analysis*, 56(2): 284-302. <https://doi.org/10.1111/gean.12374>

- [18] Amri, E., Selintung, M., Manaf, M., Nasution, M.A. (2023). Suburban development: Spatial and physical transformation of residence as a determinant of settlement densification in Makassar City, Indonesia. *International Journal of Sustainable Development & Planning*, 18(9): 2779-2789. <https://doi.org/10.18280/ijstdp.180916>
- [19] Manaf, M., Amri, E., Aksa, K. (2024). Lifestyle changes, individual mobility, and interactions in Suburban Settlement Areas of Makassar City, Indonesia: Perceptual model approach urban development policies with transport systems realizing urban sustainability. *International Review for Spatial Planning and Sustainable Development*, 12(4): 159-180. https://doi.org/10.14246/irsp.12.4_159
- [20] Chen, Q., Tang, Y., Lu, B. (2024). Exploring the evolution trends of port integration policy in China by a text mining approach. *Transport Policy*, 153: 159-172. <https://doi.org/10.1016/j.tranpol.2024.05.020>
- [21] Monios, J., Wang, Y. (2013). Spatial and institutional characteristics of inland port development in China. *GeoJournal*, 78: 897-913. <https://doi.org/10.1007/s10708-013-9473-2>
- [22] Kakar, S.M., Özçelik, Ö. (2024). Afganistan ve komşu ülkelerinde bölgesel kalkınma politikaları: Karşılaştırmalı bir analiz. *BİLTÜRK Journal of Economics and Related Studies*, 6(4): 204-234. <https://doi.org/10.47103/bilturk.1552966>
- [23] Kennedy, L. (2007). Regional industrial policies driving peri-urban dynamics in Hyderabad, India. *Cities*, 24(2): 95-109. <https://doi.org/10.1016/j.cities.2006.06.001>
- [24] Haiduc, O., Nicoară, A., Neagu, S. (2024). Transport infrastructure development and economic growth in The European Union. *Economic Sciences, The Annals of the University of Oradea*, pp. 59-66. [https://doi.org/10.47535/1991AUOES33\(1\)007](https://doi.org/10.47535/1991AUOES33(1)007)
- [25] Kumar, N.P. (2019). Regional disparities in economic and social development. *Growth, Disparities and Inclusive Development in India: Perspectives from the Indian State of Uttar Pradesh*, Springer, Singapore, 103-130. https://doi.org/10.1007/978-981-13-6443-3_5
- [26] Kazancheva, K.K., Kunasheva, Z.A., Kumysheva, Z.K., Uyanaeva, H.B., Makhoshev, A.A. (2021). Patterns and trends in the social and economic development of regional economies. *European Proceedings of Social and Behavioural Sciences*, pp. 992-997. <https://doi.org/10.15405/epsbs.2021.11.132>
- [27] Maida, C.A., Xiong, D., Marcus, M., Zhou, L., Huang, Y., Lyu, Y., Shen, J., Osuna-Garcia, A., Liu, H. (2022). Quantitative data collection approaches in subject-reported oral health research: A scoping review. *BMC Oral Health*, 22(1): 435. <https://doi.org/10.1186/s12903-022-02399-5>
- [28] Bell, J., Thompson, K.M., Palmer, K., McCarthy, G., Barrett, M., Burrows, E., Nel, P. (2022). Collaborative development of polymer-based collection survey methodology and relational data Model. *Studies in Conservation*, 67(sup1): 10-22. <https://doi.org/10.1080/00393630.2022.2049034>
- [29] Goodhue, D., Lewis, W., Thompson, R. (2006). PLS, small sample size, and statistical power in MIS research. In *Proceedings of the 39th Annual Hawaii International Conference on System Sciences (HICSS'06)*, Kauai, HI, USA, 8: 202b-202b. <https://doi.org/10.1109/HICSS.2006.381>
- [30] Deng, L., Yang, M., Marcoulides, K.M. (2018). Structural equation modeling with many variables: A systematic review of issues and developments. *Frontiers in Psychology*, 9: 580. <https://doi.org/10.3389/fpsyg.2018.00580>
- [31] Hair, J.F., Risher, J.J., Sarstedt, M., Ringle, C.M. (2019). When to use and how to report the results of PLS-SEM. *European Business Review*, 31(1): 2-24. <https://doi.org/10.1108/EBR-11-2018-0203>
- [32] Hair, J.F., Sarstedt, M., Ringle, C.M. (2019). Rethinking some of the rethinking of partial least squares. *European Journal of Marketing*, 53(4): 566-584. <https://doi.org/10.1108/EJM-10-2018-0665>